

High Speed Mini Centrifuge Quick Guide

Operation panel

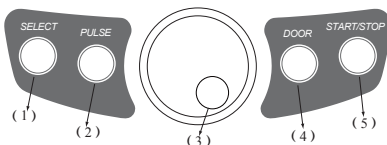
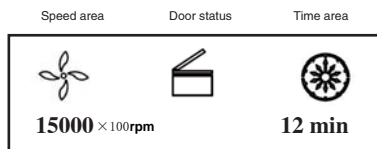

Item	Symbol	Name	Function
1		Select button	Press the button to choose the program which you want to modify.
2		Pulse button	The speed can be accelerated and held at the set speed when pressing Pulse button.
3		Program button	Clockwise rotate to increase program values. Rotate anti-clockwise to decrease program values. Press the button, shift between speed and RCF display.
4		Open/ lock button	Press the button to open the door. The button is not available when the centrifuge is running.
5		Start/ Stop button	Press the button to start running. The centrifuge will brake to stop running if pressed during centrifugation.

Operation

1、 Power on

Turn on the power switch, centrifuge will display the running interface last time after passing the self-diagnostic checks.

WARNING

- A minimum 10A outlet providing a sufficient ground is required, and this must meet local safety requirements.
- To avoid electrical shocks, insure hands are dry before handling the power cord or turn on/off the power switch.
- The centrifuge must be grounded properly.

2、 Load Rotor

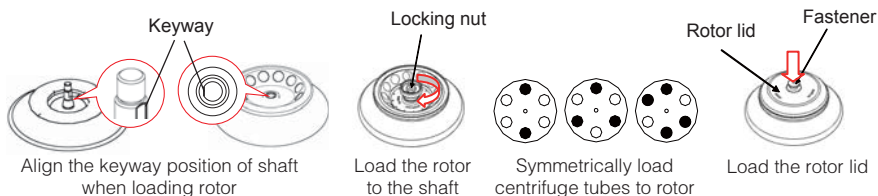

12300114

WARNING

- Load the rotor to the shaft to ensure rotor is attached well with the shaft.
- Symmetrically load centrifuge tubes to rotor.
- Never intentionally run the centrifuge under unbalanced condition even though the allowable imbalance is not exceeded.

3、 Set the operation program

Press the button to select required program. The value can be modified when the program is flashing. Rotate the program button clockwise to increase parameter value; anti-clockwise rotate the program button to decrease parameter value.

(1) Set the speed

- When the speed button is selected, the speed symbol will flash the speed value.
- The minimum speed value you can set 500rpm, the minimum increment is 100rpm.
- Rotate program button clockwise to increase speed value; rotate the program button anti-clockwise to decrease speed value.

(2) Set the time

- Press select button , time value flashes in the time setting mode.
- Rotate the program button to set running time from 30 seconds to 99 minutes.
- When the time displays HD, this is a continuous running mode.

4、 Start and end the operation

(1) Press running button to start operation.

- Timer will operate once the speed setting value is reached, the screen displays the remaining run time.

(2) The centrifuge will brake when it reaches the setting time or button is pressed.

- When the rotor stops rotating, centrifuge will start beeping to alarm the operation was over.
- The door can be released automatically when the operation was over.
- After door closed, you are able to press the button to open it.

Pulse Operation

This function is used to remove the residual samples adhered to the interior of the tubes or for quick spins. Press knob and hold, the centrifuge will speed up the setting speed. While releasing knob during acceleration, the centrifuge will start to decelerate and stop.

USER MANUAL

SCI-12 High Speed Mini Micro-Centrifuge



SCILOGEX, LLC

www.scilogex.com

Before using centrifuge, please carefully read this user manual for efficient operation and safety.

Contents

Copyright	3
Safety Reminder	4
1. Specifications	6
2. Declaration of Conformity	6
3. Required Operation Conditions	7
4. Installation	7
4.1 Location.....	7
4.2 Connection of the Power Cord and Grounding.....	7
5. Structure	8
6. Operation Panel	9
7. Rotor Preparation	10
7.1 Prepare the Sample.....	10
7.2 Inject the Sample into Tubes.....	10
7.3 Keep the Tubes Balance.....	10
7.4 Inspect the Rotor.....	10
7.5 Symmetrically Load Centrifuge Tubes to Rotor.....	10
8. Operation	11
8.1 Normal Operation.....	11
8.2 RCF Operation.....	13
8.3 Pulse Operation.....	14
9. Maintenance	14
10. Troubleshooting	15
10.1 Possible Problems and Solutions.....	15
10.2 How to Open the Door.....	15
11. Instructions for the Rotor and Tubes	16
11.1 Rotor Instructions.....	16
11.2 Tubes.....	17
12. Calculate RCF	18
13. Ordering Information	18
14. Warranty	19
14.1 Warranty of the Centrifuge.....	19
14.2 Warranty of the Rotor.....	19
15. After-sales Service	19

Copyright:

No part of this manual may be reproduced or transmitted without prior written permission of SCILOGEX.

We can not be responsible to inform at real-time if the outline and specifications of centrifuge are subject to change for improvement.

VERSION201104

Safety Reminder

Common safety precautions

Carefully read the following safety precautions for a thorough understanding.

- Follow the instructions and procedures described in this manual to operate this centrifuge safely.
- Carefully read all safety messages in this manual and the safety instructions on the centrifuge.
- Safety messages are labeled as indicated below. They are in combination with signal words of “WARNING” and “CAUTION” with the safety alert symbol to call your attention to items or operations that could be dangerous to you or other persons using this centrifuge. The definitions of signal words are as follows:

 **WARNING:** Personal Danger

Warning notes indicate any condition or practice, which if not strictly observed, could result in personal injury or possible death.

 **CAUTION:** Possible damage to centrifuge

Caution notes indicate any condition or practice, which if not strictly observed or remedied, could result in damage or destruction of the centrifuge.

NOTE: Notes indicate an area or subject of special merit, emphasizing either the product’s capability or common errors in operation or maintenance.

- Do not operate this centrifuge in any manner not described in this User manual. When in doubt or have any troubles with this centrifuge, ASK FOR HELP.
- The precautions described in this User manual are carefully developed in an attempt to cover all the possible risks. However, it is also important that you are alert for unexpected incidents. Be careful operating this centrifuge.

 **WARNING**

- This centrifuge is not explosion-proof. Never use explosive or flammable samples.
- Do not install the centrifuge in or near places where inflammable gases are generated or chemicals are stored.
- Do not place dangerous materials within 30cm around the centrifuge.
- Prepare all necessary safety measures before using samples that are toxic, radioactive or contaminated with pathogenic micro-organisms. Use of these is at your own responsibility.
- If the centrifuge, rotor and accessories that have been contaminated by solutions with toxic, radioactive or pathogenic materials, clean it according to the decontamination procedure as specified.
- If you require service at site, please sterilize and decontaminate the centrifuge in advance, and then notify the service center the details of the materials and procedure.
- To avoid electrical shocks, insure hands are dry before handling the power cord or turn on/off the power switch.
- For safety purposes, do not enter within 30cm around this centrifuge when it is in operation.
- While the rotor is rotating, never release the door lock.

Unauthorized repairs, disassembly or modifying the centrifuge except by our service center are strictly prohibited.

 **CAUTION**

- This centrifuge must be located on a firm and level table.
- Make sure the centrifuge is horizontal before running.
- Make sure the angle between the door and cover is greater than 70 degrees when opening the door.
- Be careful not put your fingers or hands between the door and cover while the door is open.
- Do not move or relocate the centrifuge when it is running.
- If fluid spills in the rotor chamber, please promptly clean and dry with a dry cloth to avoid sample contamination.
- Ensure to remove any objects and fragments of the tubes dropped inside the rotor chamber before running the centrifuge.
- Cautions with rotor
 - (1) Always check for corrosion and damages on the rotor surface before using it. Do not use the rotor if an abnormality is found.
 - (2) Do not set the speed beyond the allowable minimum speed of the rotor kits (rotor or adapters). Make sure to run it below the allowable minimum speed.
 - (3) Do not exceed the allowable imbalance.
 - (4) Use the rotor and tubes within their actual capacities.
 - (5) If the rotor is attached with a lid, ensure it is tightened before operation.
- If any abnormal condition occurs during operation, please stop it immediately and contact our service center. Notify the service center is a warning code if displayed.
- Vibrations are likely to damage the centrifuge, contact our service center if abnormality observed.

1. Specifications

Maximum speed	15000rpm, increment: 100rpm
Maximum RCF	15100×g, increment: 100×g
Maximum capacity	2ml×12
Timer	30 seconds -99 minutes-HOLD, continuous operation
Driving Motor	Brushless DC motor
Safety devices	Door interlock; Over-speed detector; Over-temperature detector; Automatic internal diagnosis
Power requirements	Single-phase, 110V-240V, 50Hz/60Hz, 3A
Dimensions(mm)	(L)255×(W)245×(H)140
Weight	6kgs
Additional features	Speed/RCF switch; Pulse operation; Processing display; Voice reminder

2. Declaration of Conformity

Construction in accordance with the following safety standards:
EN 61010-1
EN 61010-2-20
Construction in accordance with the following EMC standards:
EN 61326-1/ FCC Part 15 Subpart B/ IECS 001
Associated EU guidelines:
EMC-guidelines: 2004/108/EC
Centrifuge guidelines: 2006/95/EC
This ISM device complies with Canadian ICES-001.
Cet appareil ISM est conforme à la norme NMB-001 du Canada.

Changes or modifications not expressly approved by the party responsible for compliance could void the user's authority to operate the equipment.

NOTE: This centrifuge has been tested and found to comply with the limits for a Class A digital device, pursuant to Part 15 of the FCC Rules. These limits are designed to provide reasonable protection against harmful interference when the centrifuge is operated in a commercial environment. The centrifuge generates, uses, and can radiate radio frequency energy and, if not installed and used in accordance with the user manual, may cause harmful interference to radio communications. Operation of centrifuge in a residential area is likely to cause harmful interference in which case the user will be required to correct the interference.

3. Required Operation Conditions

3.1 Basic operation Conditions

- (1) Power: 110V-240V, 50Hz/60Hz, 3A.
- (2) Ambient temperature: 2°C~40°C.
- (3) Relative humidity: ≤80%.
- (4) No vibration and airflow around.
- (5) No electric dust, explosive and corrosive gases around.

3.2 Transport and storage conditions

- (1) Storage temperature: -40°C~55°C.
- (2) Relative humidity: ≤93%.

4. Installation

This section describes the instructions that you should abide when install the centrifuge to ensure your safety and the optimum performance. Before moving the centrifuge, the rotor must be removed.

WARNING

- Improper power supply may damage centrifuge.
- Make sure the power source conforms to the required power supply before connecting.

4.1 Location

- (1) Place the centrifuge on a firm, flat and level surface, ensure the four feet of this centrifuge stand on the counter firmly. Avoid installing on the slippery surface or surface prone to vibration.
- (2) Ideal ambient temperature is 20°C±5°C, avoid placing the centrifuge in direct sunlight if temperature exceeds 30°C.
- (3) Keep clear of the centrifuge at least 10cm on both sides and at least 30cm behind it to guarantee the cooling efficiency.
- (4) Keep away from heat or water to avoid sample temperature issues or centrifuge failures.

4.2 Connection of the power cord and grounding

WARNING

- To avoid electrical shocks, ensure your hands are dry when touching the power cord.
- This centrifuge must be grounded properly.

A minimum 10A outlet providing a sufficient ground is required, and this must meet local safety requirements.

5. Structure

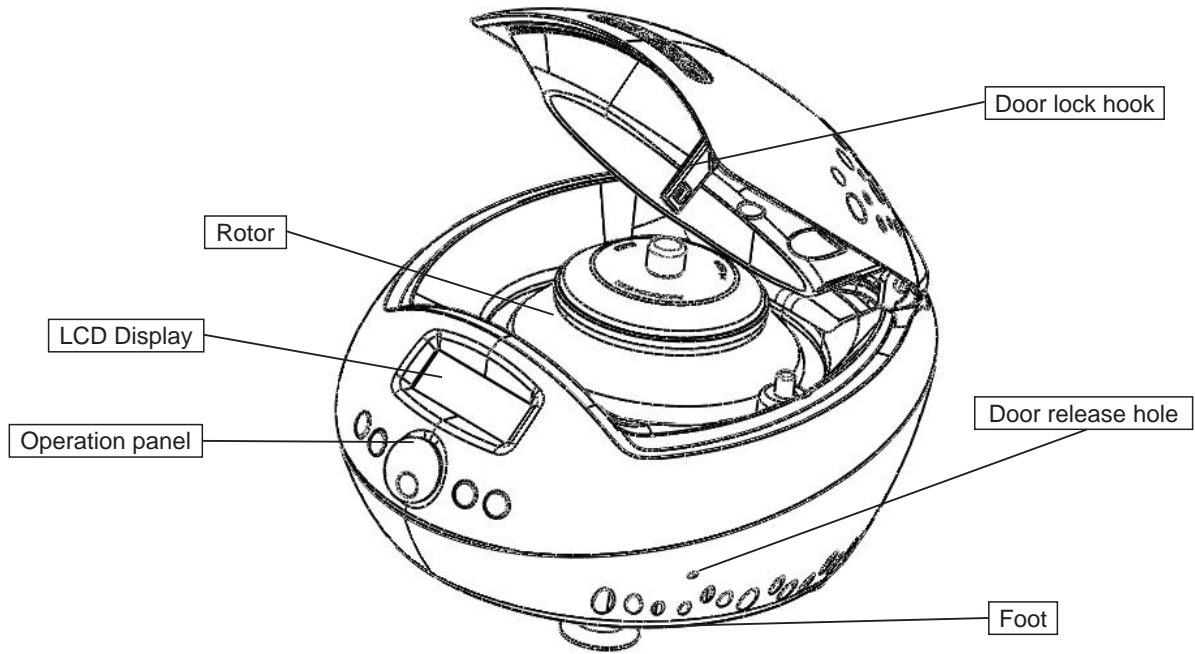

Figure 5.1 Front view of centrifuge SCI-12

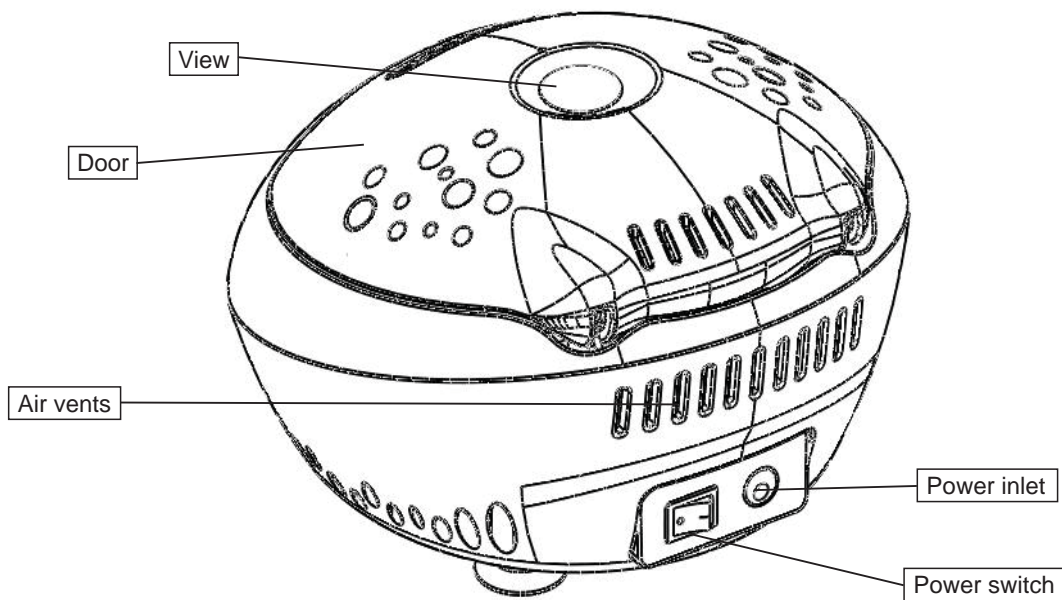

Figure 5.2 Rear view of centrifuge SCI-12

6. Operation Panel

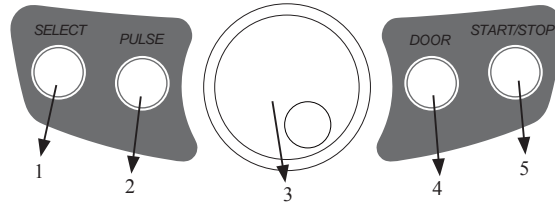

Figure 6-1 Operation panel

Item	Symbol	Name	Function
1		Select button	Press the button to choose the program which you want to modify.
2		Pulse button	The speed can be accelerated and held at the set speed when pressing Pulse button.
3		Program button	Clockwise rotate to increase program values. Rotate anti-clockwise to decrease program values. Press the button, shift between speed and RCF display.
4		Open/ lock button	Press the button to open the door. The button is not available when the centrifuge is running.
5		Start/ Stop button	Press the button to start running. The centrifuge will brake to stop running if pressed during centrifugation.

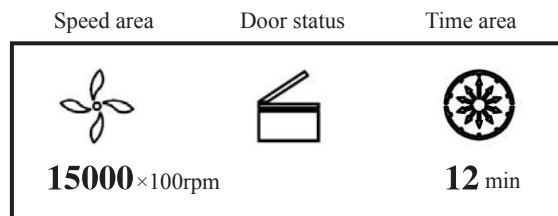

Figure 6-2 The main interface

Main interface is as figure 6-2. The speed is set to be 15000 rpm, running time is 12 minutes. When speed symbol is rotating, indicating the centrifuge is running. Time display symbol displays the ratio of working to time setting. The total time setting is divided into 10 sections.

7. Rotor Preparation

7.1 Prepare the samples

7.2 Inject the samples into tubes

CAUTION

- Do not overload samples into the centrifuge which will cause leaking.
- Do not exceed the actual capacity allowed in the user manual.

7.3 Keep the tubes balance

- Although the centrifuge can accept sample balancing by eye, we recommend that you keep this centrifuge in a well-balanced condition to extend its life expectancy.
- Never intentionally run the centrifuge under unbalanced condition even though the allowable imbalance is not exceeded.

7.4 Inspect the rotor

Check the rotor for corrosion or scratches before using.

CAUTION

- Any abnormality such as corrosion or scratches are found, stop using the rotor and contact our service center.
- Only manufacturer's rotors must be used with the unit.

7.5 Symmetrically load centrifuge tubes to rotor

- Make sure the rotor lid is securely fixed on the rotor, as well as the rotor and shaft are tightened. Otherwise, the rotor may be moved off while rotating and cause damages of the centrifuge and rotor.

8. Operation

CAUTION

- Do not push or lean against the centrifuge while it is running.
- Do not run the centrifuge when fragments or sample solutions are left in the centrifuge chamber. Always keep the centrifugal chamber clean.
- If the centrifuge makes strange noise during operation, stop it immediately and contact our service center. Notify them of the warning code if displayed.

8.1 Normal operation

Turn on the power switch, centrifuge will display the running interface last time after passing the self-diagnostic checks, see figure 8-1 below:

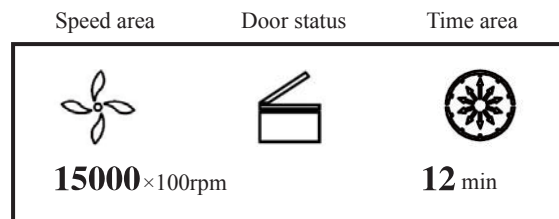

Figure 8-1 The last running interface

- Speed: 15000rpm. Running time: 12 minutes.
- The door lock is released.

8.1.1 Rotor loading and removal

CAUTION

- Attach the rotor to the rotor shaft. Ensure the rotor is in position and connected with the shaft, tightening the locking nut to secure the rotor with shaft, to prevent the rotor damaging the centrifuge.
- Ensure the rotor lid is firmly tightened to the rotor.

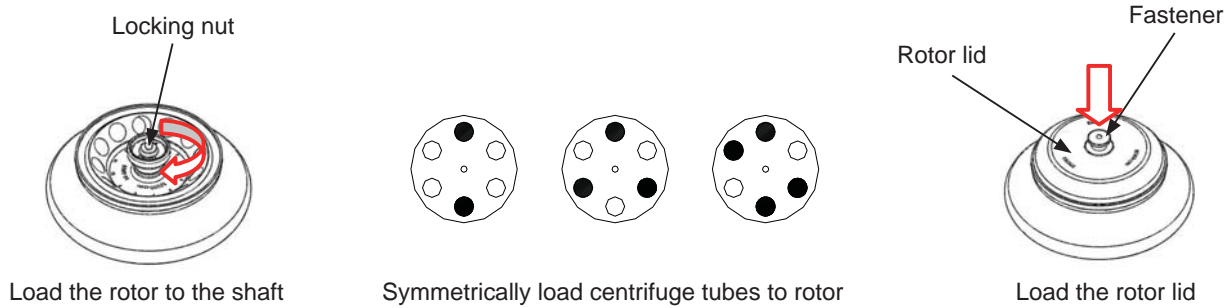





Figure 8-2 The rotor installation

- Load the rotor to the shaft to ensure rotor is in position until it connected well with the shaft.
- Rotate the rotor slightly with your fingers to check. if the rotor vibrates, if so attach the rotor again.
- Hold on the rotor with one hand, tighten clockwise the nut with the other hand and make sure tighten firmly.
- Put the rotor lid to the rotor, press the fastener down and make the fastener attach the locking nut tightly.
- Close the door and start running.
- To release the rotor, firstly pull the fastener up to remove the lid, and then turn the locking nut anti-clockwise.





CAUTION

- Check the rotor is firmly tightened before running.



8.1.2 Set the operation programs

Press the **Select** button to select required program. The value can be modified when the program is flashing. Rotate the program button clockwise  to increase value; anti-clockwise rotate the program button  to decrease value. Program button  rotate faster, and the value increase faster. The minimum speed increment is 100 rpm, the minimum time increment is 1 second.

(1) Set the speed

- Press the select button **Select** until the speed rpm is displayed.
- When the speed button is selected, the speed symbol will flash the speed value.
- The minimum speed value you can set 500 rpm, the minimum increment is 100 rpm.
- Rotate program button clockwise  to increase speed value; rotate the program button anti-clockwise  to decrease speed value.
- You can speed-up set the speed value by rotating program button  quickly.
- There is a circulating function to increase/decrease the speed values. Rotate the program button clockwise  to change settings from small → large → maximum → minimum. Rotate the program button anti-clockwise  to change settings from large → small → minimum → maximum.



(2) Set the time

- Press button , time value flashes in the time setting mode.
- Rotate the program button  to set running time from 30 seconds to 99 minutes.
- When the time displays HD, this is a continuous running mode.

8.1.3 Start the operation(1) Press button  to start running

- Timer will operate once the speed setting value is reached, the screen displays the remaining run time.

(2) View and modify the operation programs

- Pressing button  returns the display to the program interface and displays setting programs. Press the select button  to the desired program. When flashing, rotate parameter button  to modify values. Release the button after 5 seconds, and the centrifuge will return to normal operation mode and run according to the new value.
- If the set time value has been modified, the operation time is not affected and will continue.

(3) Warning display

- If an error occurs during the operation, the centrifuge will brake to stop automatically, and display the error code on the time/display area. The error code can be checked in the table 10-1, and corrective actions can be applied accordingly.

8.1.4 End the operation(1) The centrifuge will brake when it reaches the setting time or  button is pressed.

- When the rotor stops rotating, the centrifuge will start beeping to alert the operation has finished.

(2) Open the door



- The door can be released automatically when the operation has stopped.
- With the door closed, you are able to press the  button to open it.
- After ending the operation, the program will store the setting parameters of this operation, and will recall these parameters when restarting the program.

(3) Open the door and take out the rotor and samples.

8.2 RCF operation

(1) Turn on the power switch

(2) Set a RCF (Relative Centrifugal Force) value

- Press the select button  and choose speed unit $\times g$, the speed symbol will flash into RCF value input status.
- If no button is pressed after the speed value has flashed for 5 seconds, the input mode will be shut down.
- Rotate program button  to input a RCF value, RCF increment is $100\times g$.



(3) Set operating conditions

The other operation, please refer to the section 8.1.

8.3 Pulse operation

This function is used to remove the residual samples adhered to the interior of the tubes or for quick spins.

Note: The button works only while the rotor stopped and the door is locked.

- (1) Turn on the power switch and load the rotor to the shaft, tighten the rotor lid and make sure it is in secured position, and then close the door.
- (2) The centrifuge gets into preparation mode and displays last running values. The values can be reset.
- (3) Press  knob and hold, the centrifuge will speed up to the setting speed. While releasing the  knob during acceleration, the centrifuge will start to decelerate and stop.

9. Maintenance

CAUTION

- If do not follow the recommended instructions for cleaning or disinfecting may damage the centrifuge.

(1) Centrifuge

- If the centrifuge is exposed to ultraviolet rays for a long time, the color of the door may be changed or the label may be came off. After using, cover the centrifuge with a piece of cloth to protect it from direct exposure.
- If the centrifuge needs cleaning, clean it with a cloth or sponge moistened with a neutral detergent solution.
- Sterilize the centrifuge by wiping with a cloth moistened with 70% ethanol solution.

(2) Rotor chamber

CAUTION

- Do not directly pour water, neutral detergent or disinfectant solution into the rotor chamber, otherwise fluids may leak into the drive units and cause corrosion or deterioration to the bearings.

- If the rotor chamber needs cleaning, clean with cloth or sponge moistened with a neutral detergent solution. Sterilize the centrifuge by wiping with a cloth moistened with 70% ethanol solution.

(3) Drive shaft

- We recommend regular maintenance for drive shaft. You can wipe the drive shaft with soft cloth, and then apply a thin coat of silicon grease.

(4) Door

- Clean and sterilize the door using the same method as the section(1)above.

(5) Rotor

- To prevent corrosion, remove the rotor from rotor chamber. If not in use for a lone term, then detach the rotor lid and turn upside down to dry the tube holes and keep clean.
- For sample leaks in the rotor, rinse the rotor with water. Apply a thin coat of silicon grease to the rotor when it is completely dry.
- The rotor should be checked every 3 months to ensure the tube and rotor holes keep are clean and apply a thin coat of silicon grease.

10. Troubleshooting

10.1 Possible problems and solutions

This centrifuge has a self-diagnostic function. If a problem occurs, an error/warning code will be displayed on the time display screen and the operator can determine the malfunction with the warning code below.

Symptom		Causes	Solutions
Nothing appears on the screen when the power is turned on.		<ul style="list-style-type: none"> •Building power circuit breaker trips. •The fuse was blown out. 	<ul style="list-style-type: none"> •Remove the trouble and turn on the power. •Replace the fuse.
Abnormal vibration		<ul style="list-style-type: none"> •Rotor do not match with shaft •Samples are imbalance •Rotor lid loosed 	<ul style="list-style-type: none"> •Install again the rotor •Weighting scales, install symmetrically •Tighten the rotor lid firmly
Alarm code appeared on the time display screen	E-02 Door fault	<ul style="list-style-type: none"> •The door opened during running. •Press the button while the door is opening. 	<ul style="list-style-type: none"> •Close the door immediately. •Close the door and then start to operate.
	E-06 Set wrong speed	<ul style="list-style-type: none"> •The setting speed exceed the allowable range. 	<ul style="list-style-type: none"> •Modify the speed value.
	E-10 ~ 86	<ul style="list-style-type: none"> •Read the service manual 	<ul style="list-style-type: none"> •Contact with service center

Table 10-1 Possible problems and solutions

- Warning code E-1~E-9 are related to wrong operating. You can continue running the centrifuge after the cause removed.

10.2 How to open the door

10.2.1 In the case of power on

CAUTION

- The door just can be opened while the power is on and rotor stops rotating.

- (1) Turn on the power switch, release the door automatically.
- (2) The door will be released automatically once the operation is finished.
- (3) It is available to release the door by pressing button  once the rotor stops.

10.2.2 In the case of power outage

The door cannot be opened automatically if there is a power outage. It is available to be opened manually as follows.

- (1) Ensure if the rotor has stopped rotating.
 - Listen carefully to ensure no rotating sound can be heard.
- (2) Insert a screw driver into the hole to open the door.
 - Hole is located on the top right side of the unit.
 - Insert a screw driver into the hole and push forward to release the door.

11. Instructions for the Rotor and Tubes

! CAUTION

- Read the user manual thoroughly to properly load and use rotor.
- Do not exceed the allowable maximum speed of rotor tube and adapters etc.. Ensure the allowable maximum speed of adapters is lower than the rotor's maximum speed.

11.1 Rotor instructions

11.1.1 Rotor structure

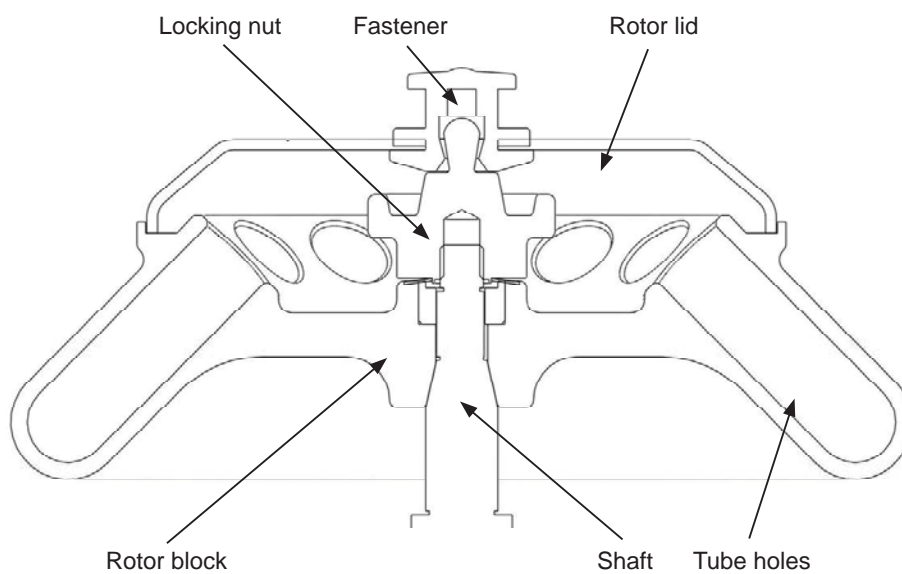

Figure11-1 The rotor structure

11.1.2 Available rotors and adapters

The rotor can be used as follows:

Table 11.1 Rotors and adapters

Rotor type	ID code	Tubes	Adapters	Maximum speed (rpm)	Maximum RCF (×g)	Allowable imbalance(*)	
						Imbalance	Volume imbalance
A12-2	01	1.5/2.0ml tube		15000	15100	2.0g/ tube	5mm/ tube
		0.2ml PCR tube	A02P2	15000	15100		
		0.5ml micro tube	A05P2	15000	15100		

11.1.3 Notice

The centrifuge rotor can separate samples which density lower than 2.0 g/ml. If the separated samples density is over 2.0 g/ml, please calculate allowable speed depending on the following formula.

$$\text{Allow Speed (rpm)} = \text{Maximum speed} \times (2.0 \text{ (g/ml)} / \text{Sample density (g/ml)})^{1/2}$$

11.1.4 Autoclaving

The rotor is manufactured in high-strength aluminum alloy material and can be autoclaved: 121°C(1.0kg/cm²)20 minutes.



- The lid of the rotor is made of plastic, can not be high-pressure sterilization, only ordinary sterilization can be used.

11.2 Tubes

11.2.1 Cleaning and sterilizing tubes

Table 11.2 Cleaning and sterilizing conditions for tubes

O:Applicable X:Inapplicable

Conditions		Materials	PA	PC	PP
Cleaning	Cleaning fluids	Acidic(pH5 or lower)	X	X	X
		Acidic(higher than pH5)	O	O	O
		Alkaline(higher than pH9)	O	X	O
		Alkaline(pH9 or lower)	O	O	O
		Neutral(pH7)	O	O	O
		Warm water(up to 70°C)	O	O	O
	Ultrasonic cleaning	Neutral detergent(pH7)	O	O	O
Sterilization	Autoclaving	115°C(0.7kg/cm ²)30minutes	O	O	O
		121°C(1.0kg/cm ²)20 minutes	X	O	O
		126°C(1.4kg/cm ²)15 minutes	X	X	X
	Boiling	15 to 30 minutes	O	O	O
	Ultraviolet sterilization	200-300nm	X	X	X
Gas sterilization		Ethylene oxide	O	X	O
		Formaldehyde	O	O	O

PA:Polyallomer; PC:Polycarbonate; PP:Polypropylene

11.2.2 Cleaning PC tubes

PC material is low in chemical resistance against alkaline solutions. Avoid using neutral detergents with pH higher than 9. Note that pH of some neutral detergents are still higher than 9 even if diluted according to the the manufacturer’s instruction. Use detergent with its pH between 7 and 9.

11.2.3 Autoclaving PA、PC and PP tubes

PA begins softening at about 120°C, PC and PP at about 130°C. Autoclave PA tubes at 115°C (0.7kg/cm²) for 30 minutes, PC and PP tubes at 121°C (0.1kg/cm²) for 20 minutes. If a certain temperature is exceeded, the tubes may be deformed.

When use a sterilizing chamber, please operate as follows:

- (1) Place tubes in vertical position, mouths upward. If tubes are placed sideways, they may deform into an oval shaped due to gravity.
- (2) Remove locking nut and lid to prevent from deformation or rupture.
- (3) Wait until the sterilizing chamber cools down to the room temperature before removing tubes.

11.2.4 Conditions and life expectancy of tubes

The life expectancy of plastic tubes depends on the characteristics of samples, speed of the rotor used, temperature applied and so on. When the plastic tubes are used for ordinary aqueous samples (pH between 5 and 9), their life expectancies are defined as follows.

Be operated at the maximum speed:

High quality tubes (PA、PC、PP): 30-50 operations

Ordinary tubes (PA、PC、PP): around 10 operations(Using in low speed can extend the tube life)

Life expectancy of tubes also depends on the pretreatment conditions such as cleaning and sterilization, lifetime can be cut down.

Notice: Do not use damaged or cracked tubes.

12. Calculate RCF

Relative Centrifuge Force (RCF) can be determined with the following calculation formula.

$$RCF = 1.118 \times r \times n^2 \times 10^{-5}$$

R — rotating radius, unit: cm; n — rotating speed, unit: rpm

13. Ordering Information

Cat. No.	Model	Descriptions
911015119999	SCI-12	High Speed Mini Micro-Centrifuge, with A12-2 rotor kits, US plug, 110V-240V/50Hz/60Hz
911115119999	SCI-12	High Speed Mini Micro-Centrifuge, with A12-2 rotor kits, Cn plug, 110V-240V/50Hz/60Hz
911215119999	SCI-12	High Speed Mini Micro-Centrifuge, with A12-2 rotor kits, Euro plug, 110V-240V/50Hz/60Hz
911315119999	SCI-12	High Speed Mini Micro-Centrifuge, with A12-2 rotor kits, UK plug, 110V-240V/50Hz/60Hz
Accessories		
19400005	A12-2	Rotor kits with lid, fixing clips and O'ring, 15000rpm, 2ml*12, used with SCI-12
19500001	A02P2	0.2ml rotor adapter, used with A12-2 & AS24-2 rotors, 24pcs/pk
19500002	A05P2	0.5ml rotor adapter, used with A12-2 & AS24-2 rotors, 24pcs/pk

14. Warranty

14.1 Warranty of the centrifuge

This centrifuge is guaranteed for two years from the date of delivery provided that it has been operated and maintained properly.

14.2 Warranty of the rotor

The rotor is guaranteed for 5 years from the date of delivery upon manufacturer. Please pay attention, do not use the rotor once it has been corrosion or fatigue damage. The warranties of the centrifuge and the rotor become invalid in the case of the following conditions even if within the guarantee period expires:

- (1) Failures caused by incorrect installation.
- (2) Failures caused by rough or improper handling.
- (3) Failures caused by conveyance or relocation after installation.
- (4) Failures caused by unauthorized disassembly or modification.
- (5) Failures caused by using non-standard spare parts or accessories and unauthorized modification of the rotor or centrifuge.
- (6) Failures caused by natural disasters including fire, earthquakes and so on.
- (7) Consumables and parts have a limited guarantee period.

15. After-sales Service

In order to ensure to operate centrifuge safely and efficiently, it is necessary for regular maintenance. If centrifuge has problems, do not attempt to repair it by yourself. Contact our sales or service center.

SCIOGEX, LLC
1275 Cromwell Ave.
Suite C6
Rocky Hill, CT 06067 USA
Tel: +1(860) 436-9221
Fax: +1(860) 436-9745
info@scilogex.com | www.scilogex.com